

Warnings:

- Risk of fire or electric shock.
- **Disconnect all power before installing or servicing.**
- Installation Instructions for qualified electricians only.
- Install per National Electrical Code and local regulations.
- Read Installation Instructions completely before installation.
- Failure to follow Installation Instructions may void warranties.
- Always use correct lamp type and wattages.

**EF400 CHANNEL SERIES
INSTALLATION OVERVIEW**

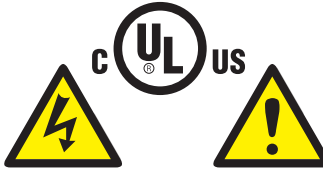

THIS PRODUCT MUST BE INSTALLED IN ACCORDANCE WITH THE APPLICABLE INSTALLATION CODE BY A PERSON FAMILIAR WITH THE CONSTRUCTION AND OPERATION OF THE PRODUCT AND THE HAZARDS INVOLVED.

Pre-Installation Note: PLEASE REVIEW ELECTRICAL PRIOR TO INSTALLATION OF FIXTURE. For installations where wiring access to housing is limited, it is advised to pre-wire the housing with leads before installation.

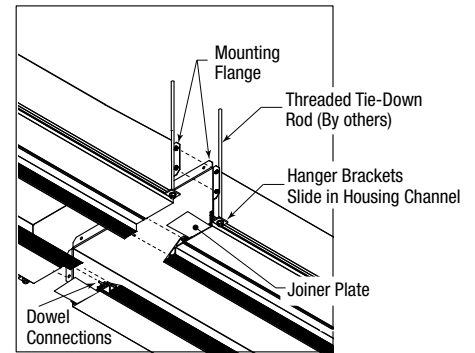
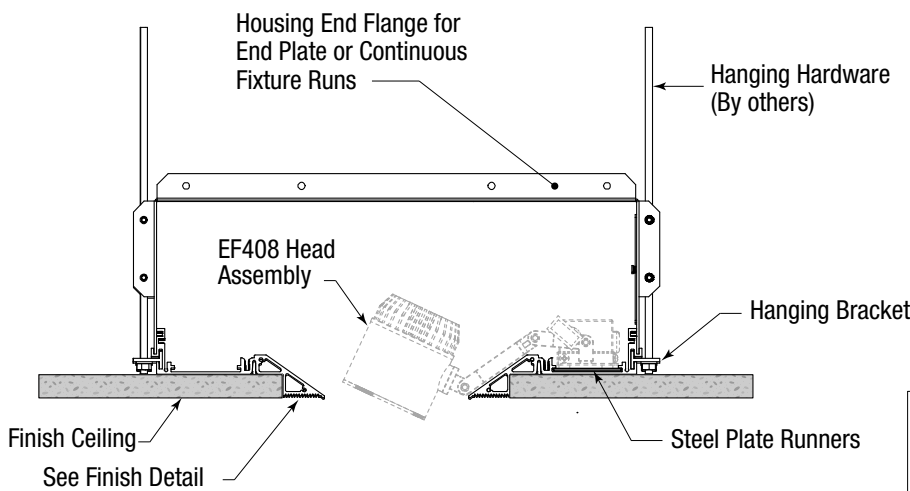

CHANNEL PROFILE

SINGLE AND CONTINUOUS INSTALLATION:

1. Slide suspended ceiling hanger brackets into and along both sides of housing channel to desired position.
2. Insert dowel connections (joiner plates pre-installed) into each end of channel that will be joined for a continuous run or corner connection.
3. Attach suspension hardware to hanger brackets (threaded tie-down rods or wire ties by others).
4. IT IS IMPORTANT to maintain the width of the open aperture during installation.
5. Join all continuous runs at dowel and joiner bracket locations. Bolt together all channel flanges and end plates (See detail page 2).
6. Channel fixtures are magnetically secured and provided with a starter box, jumper wires and power supply units (See page 3 for details).
7. Install drywall ceiling and fasten using drywall screws to extruded edge (see finish detail). Countersink screw heads partially into ceiling material allowing for mudding compound to cover for a smooth screed edge finish.
8. Finish by screeding the mudding compound from the ceiling material, over the ceiling screws and on to the edge of the extrusion creating a "Zero Edge" appearance.

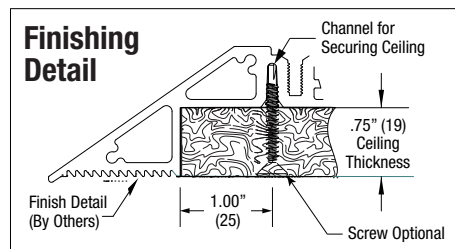
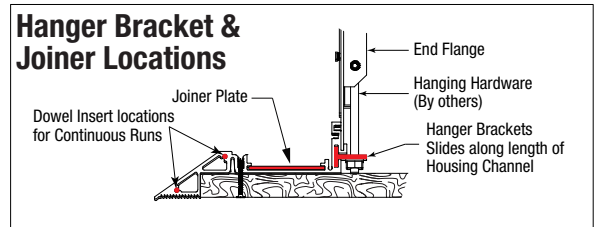
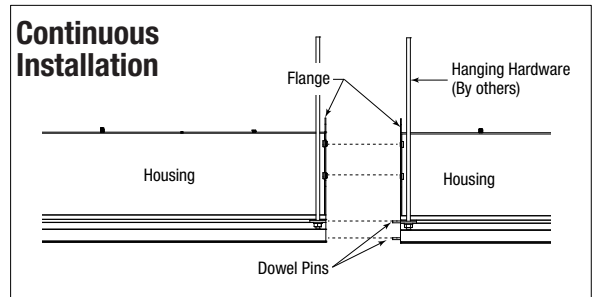

Warnings:

- Risk of fire or electric shock.
- **Disconnect all power before installing or servicing.**
- Installation Instructions for qualified electricians only.
- Install per National Electrical Code and local regulations.
- Read Installation Instructions completely before installation.
- Failure to follow Installation Instructions may void warranties.
- Always use correct lamp type and wattages.

**EF400 SERIES
INSTALLATION OVERVIEW**

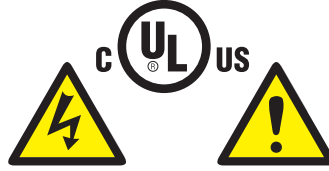

THIS PRODUCT MUST BE INSTALLED IN ACCORDANCE WITH THE APPLICABLE INSTALLATION CODE BY A PERSON FAMILIAR WITH THE CONSTRUCTION AND OPERATION OF THE PRODUCT AND THE HAZARDS INVOLVED.

Pre-Installation Note: PLEASE REVIEW ELECTRICAL PRIOR TO INSTALLATION OF FIXTURE. For installations where wiring access to housing is limited, it is advised to pre-wire the housing with leads before installation.

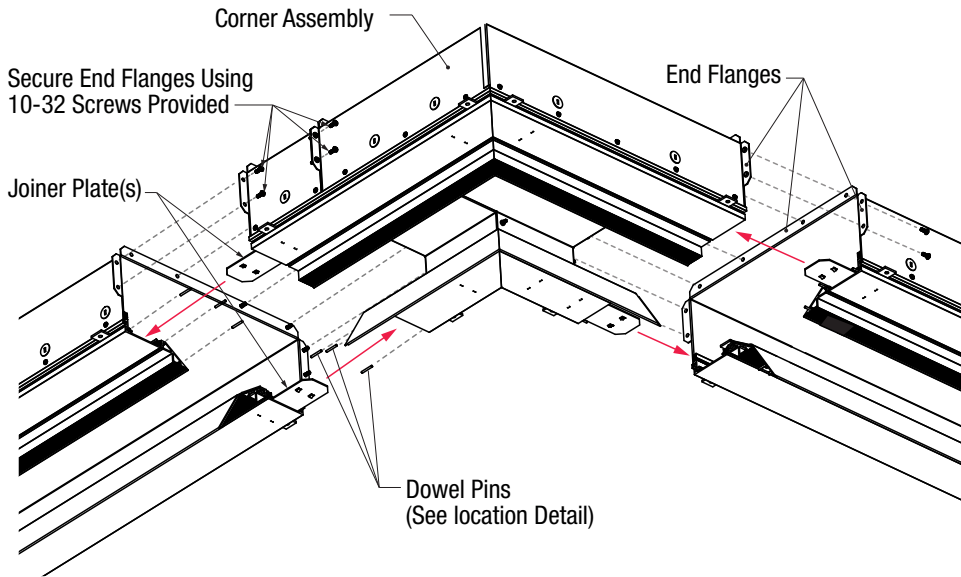

CORNER HOUSING ASSEMBLY

End Flanges Fasten @ Each Location using 10-32 Screws Supplied

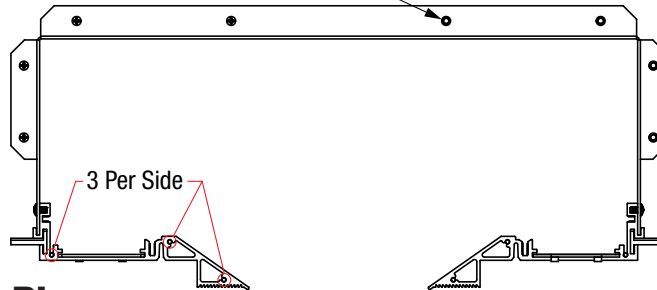

Dowel Pin Locations

CHANNEL PROFILE

Warnings:

- Risk of fire or electric shock.
- **Disconnect all power before installing or servicing.**
- Installation Instructions for qualified electricians only.
- Install per National Electrical Code and local regulations.
- Read Installation Instructions completely before installation.
- Failure to follow Installation Instructions may void warranties.
- Always use correct lamp type and wattages.

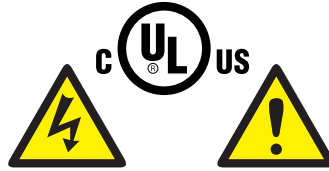

THIS PRODUCT MUST BE INSTALLED IN ACCORDANCE WITH THE APPLICABLE INSTALLATION CODE BY A PERSON FAMILIAR WITH THE CONSTRUCTION AND OPERATION OF THE PRODUCT AND THE HAZARDS INVOLVED.

COMPONENT INSTALLATION:

1. STARTING RUN - Install #EF4FD-U-XX Starter Box. Box is secured using magnetic mounting Remove knock-out.
2. Attach incoming power feed to starter box. If separate low voltage control wires are being run to the starter box, then use a dual conduit connector to bring both cables into starter box. Each starter is **rated up to 7A** and has 2 dimming wires included (for 0-10V, Eco-System and other control wiring as required).
3. Daisy chain fixtures together (typically #EF407, EF408, EF410) using the quick connect plugs. For fixtures further than 2' apart, jumpers may be used. (Reference jumper schedule below)

EF4FD
POWER STARTER FEED
Electrical Component

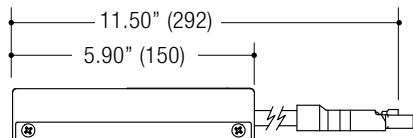
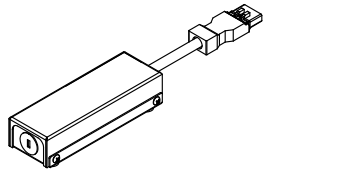

Magnetic Mount

Starter box

EFXJW
JUMPER WIRE
Electrical Component

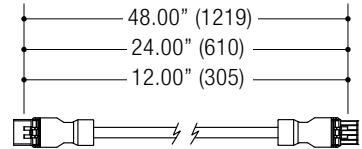
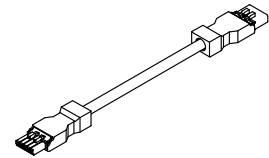

Jumper Wire

TYPICAL COMPONENT INSTALLATION

