

PROJECT	TYPE	CATALOG NUMBER
---------	------	----------------

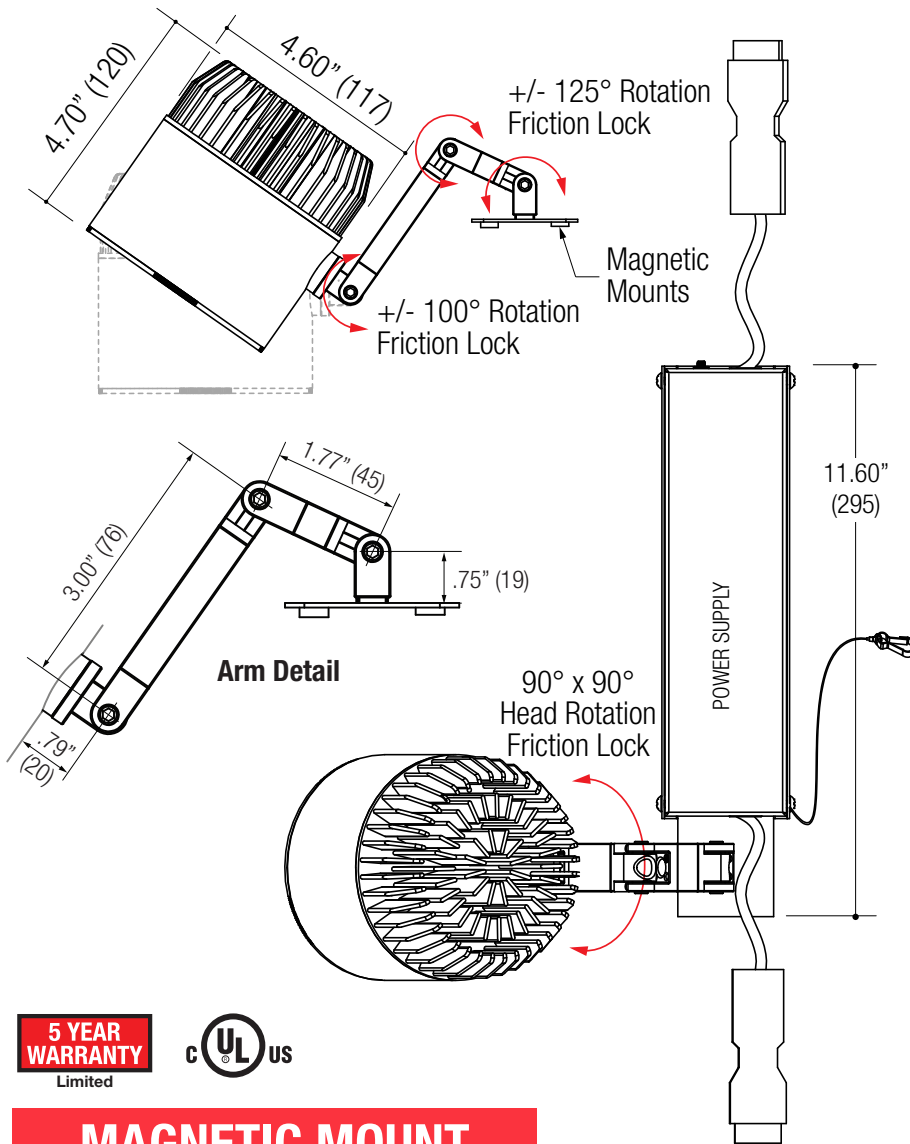

Specifications

SPOTLIGHT

- 4.60" diameter cylinder
- 125° x 125° arm articulation - Friction lock
- 90° x 90° head rotation - Friction lock
- Die-cast aluminum optical housing
- Articulating arm allows for greater aiming
- Powder coat finish

LED SOURCE

- Field-replaceable integral LED module
- Field-changeable optic
- CREE
- Easy access via front ring snap-in catch action
- Accepts 1 or more optical accessories

ELECTRICAL

- Field-replaceable LED driver
- Dimmable

MOUNTING

- Fabricated steel extension arm
- Side channel magnetic mount
- Designed for EF400 - EF4DNS Channel

LABELS

- Suitable for damp location

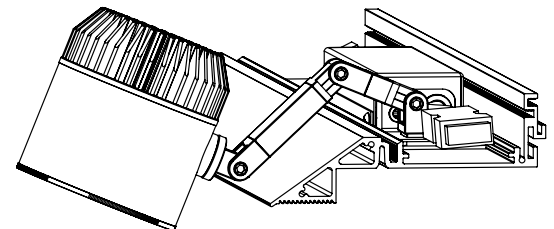

Application View

EF400 / EFDNS Channel Shown





MAGNETIC MOUNT

ORDERING INFO

SERIES	WATTAGE	CRI / COLOR	BEAM	DRIVER / VOLTAGE	FINISH
EF408D	34C 34W LED 2727 lm del.	8027 80CRI / 2700K	N Narrow 15°	DMU Dimming Multiple Forward/Reverse Phase (@ 120V only) 0-10V Wires Present (@ 120-277V)	BB Black WW White
		8030 80CRI / 3000K	M Medium 27°		
EF400 Cylindrical Large Die Cast Aluminum Housing Variable Adjustment EF400 - EF4DNS Channel Mount	40C 40W LED 3477 lm del. Delivered @ 80CRI / 3000K Narrow Beam	8035 80CRI / 3500K	W Wide 42°		Consult factory for custom colors. Minimum order required. Bezels only available in black or white.
		8040 80CRI / 4000K	V Very Wide 58°		
		9227 92CRI / 2700K			
		9230 92CRI / 3000K			
		9235 92CRI / 3500K			
		9240 92CRI / 4000K			

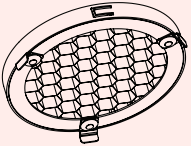
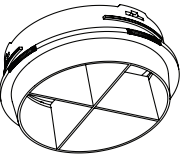
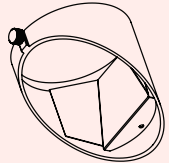
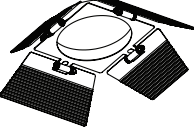
Ordering Example: **EF408D-40C-8030-N-DMU-BB**

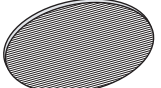
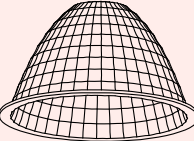
OPTICAL ACCESSORY	DESCRIPTION	LED SOURCE		
		EF208B / EF408B	EF208C / EF408C	EF208D / EF408D
	Hex Cell Louver - Black	OPT-EF208B-HXL	OPT-EF208C-HXL	OPT-EF208D-HXL
	Snoot with Cross Baffle White	OPT-EF208B-CBWW	OPT-EF208C-CBWW	OPT-EF208D-CBWW
	Snoot with Cross Baffle Black	OPT-EF208B-CBBB	OPT-EF208C-CBBB	OPT-EF208D-CBBB
	Wallwash - White	OPT-EF208B-WWWW	OPT-EF208C-WWWW	OPT-EF208D-WWWW
	Wallwash - Black	OPT-EF208B-WWBB	OPT-EF208C-WWBB	OPT-EF208D-WWBB
	Barn Doors - White	OPT-EF208B-BDWW	OPT-EF208C-BDWW	OPT-EF208D-BDWW
	Barn Doors - Black	OPT-EF208B-BDBB	OPT-EF208C-BDBB	OPT-EF208D-BDBB
	Diffused Lens	OPT-EF208B-P-DFL	OPT-EF208C-P-DFL	OPT-EF208D-PDFL
	Linear Spread Lens	OPT-EF208B-P-LSL	OPT-EF208C-P-LSL	OPT-EF208D-P-LSL
	Narrow Beam	OPT-EF208B-REFLN	OPT-EF208C-REFLN	OPT-EF208D-REFLN
	Medium Beam	OPT-EF208B-REFLM	OPT-EF208C-REFLM	OPT-EF208D-REFLM
	Wide Beam	OPT-EF208B-REFLW	OPT-EF208C-REFLW	OPT-EF208D-REFLW
	Very Wide Beam	OPT-EF208B-REFLV	N/A	OPT-EF208D-REFLV

PROJECT	TYPE	CATALOG NUMBER
---------	------	----------------

ELECTRICAL COMPONENTS

EF4FD
POWER STARTER FEED
Electrical Component

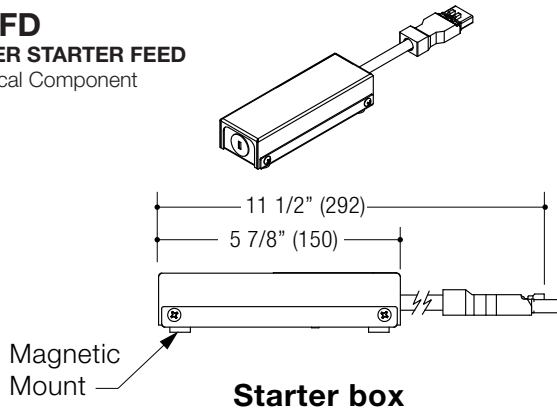

EFXJW
JUMPER WIRE
Electrical Component

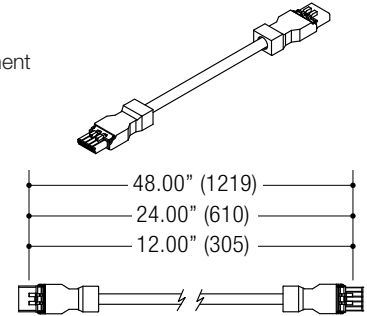

Jumper Wire

ORDERING INFO

SERIES	VOLTAGE	FINISH
EF4FD Power Starter Feed	U 5 Wire / 0-10V Capable, 7A Max.	BB Black WW White

Ordering Example: **EF4FD-U-BB**

ORDERING INFO



SERIES	DESCRIPTION	VOLTAGE	FINISH
EFXJW Jumper Wire	012 Jumper Wire 1' 024 Jumper Wire 2' 048 Jumper Wire 4'	U 5 Wire / 0-10V Capable, 7A Max.	BB Black WW White

Ordering Example: **EFXJW-024-U-BB**

TYPICAL COMPONENT INSTALLATION

