

PROJECT	TYPE	CATALOG NUMBER
---------	------	----------------

Measurements in () are metric equivalents.

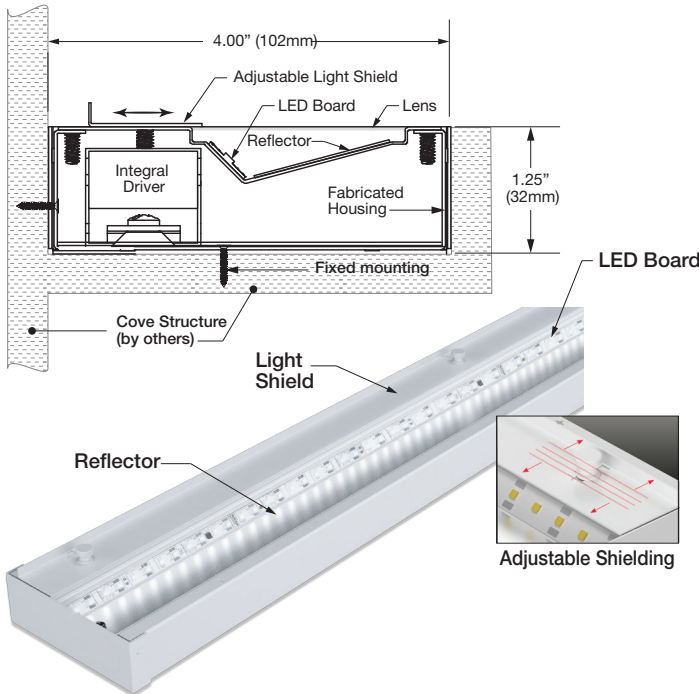

ADJUSTABLE LIGHT SHIELDING

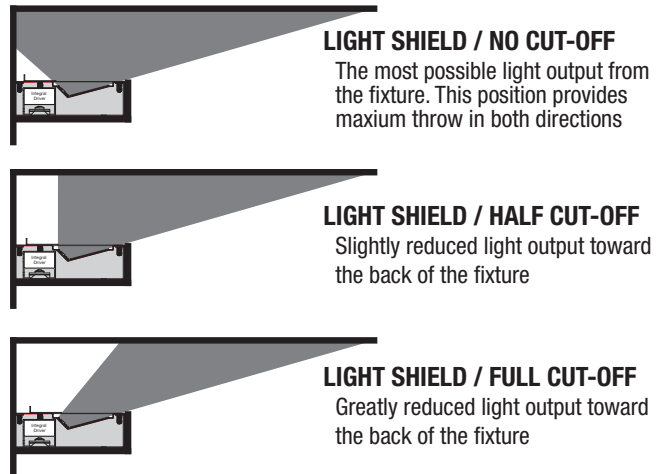

EF600 Features

- 3 Power levels up to 1040 del. lumens
- Uninterrupted illumination
- End-to-end continuous run

CONSTRUCTION

- 4.00" (102) wide x 1.25" (32) tall fabricated metal housing
- Powder coat finish

LED Source

- Available at three power levels up to 1040 del. lumens per foot
- Tight binning ensures color consistency within 2 MacAdam ellipses
- Dense pitch for uniform output

OPTICS

- Asymmetric distribution / protective clear lens
- Optional soft cutoff lens
- Integral semi-specular reflector
- Backlight shield allows user to adjust the distribution to suit the field condition

ELECTRICAL

- Field-replaceable integral LED driver
- Integral wiring compartment in housing
- Integral thermal protection
- Easy maintenance access via lens assembly
- Quick disconnect through wiring for continuous runs

MOUNTING

- Surface mount
- End-to end for continuous uninterrupted illumination
- For joiner options to connect multiple EF600 sections see page 2.

LABELS

- Suitable for damp location



ORDERING INFO

SERIES	WATTAGE / FT	CRI / COLOR	LENS	DRIVER	LENGTH	VOLTAGE	FINISH
EF6-C	04L* 04W LED 416 del. lm / ft	8027 80CRI / 2700K	PL Protective Clear Lens	D2 0-10V Dim. Driver (@ 120-277V only)	018* 18" 1.5ft	1 120V U 120-277V	WW White
		8030 80CRI / 3000K			024 24" 2ft		
	08L 08W LED 832 del. lm / ft	8035 80CRI / 3500K	SL Softening Lens	D3 Lutron Hi-lume™ Forward Phase 1% (@ 120V only)	036 36" 3ft		
		8040 80CRI / 4000K			048 48" 4ft		
		9027 90CRI / 2700K			060 60" 5ft		
10L 12W LED 1040 del. lm / ft	9030 90CRI / 3000K		DE* Lutron Hi-lume™ EcoSystem™ 1% with SoftOn, Fade-to-Black™ (@ 120-277 only)	072 72" 6ft			
	9035 90CRI / 3500K			096 96" 8ft			
EF600 Medium LED Surface mount	Delivered @ 80CRI / 3000K / 120V	Consult factory for other CRI / Color options		D8 Dimmable DALI 1% LED driver (@ 120-277 only)			
EF6-C							

Ordering Example: **EF6-C-04L-8027-PL-D2-048-U-WW**

PROJECT

TYPE

CATALOG NUMBER

ELBOW JOINER KIT

- Elbow joiner for curved / angled applications
- 0-90° joint motion
- Top or bottom pin locations for reverse action

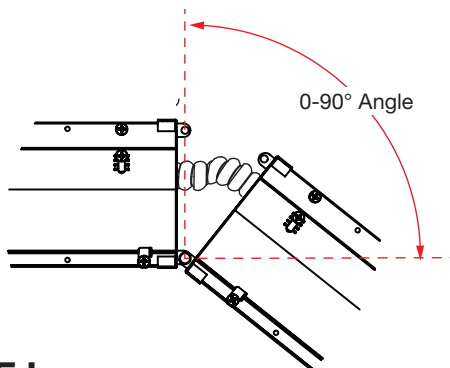

EF6-C-EJ

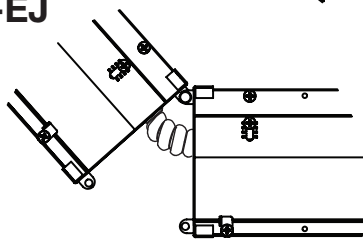

Kit Includes

- 2 End Caps
- 1 Hinge Pin
- 1 Cotter Key
- Armored Conduit Electrical Whip

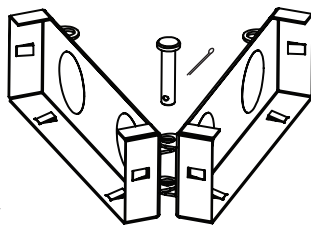

ORDERING INFO

SERIES	FINISH
EF6-C-EJ	WW White
ELBOW JOINER KIT White Finish	
EF6-C	

Ordering Example: **EF6-C-EJ-WW**

STRAIGHT JOINER KIT

- Smooth continuous run applications
- Easy snap-in joiner
- Quick-disconnects power supply

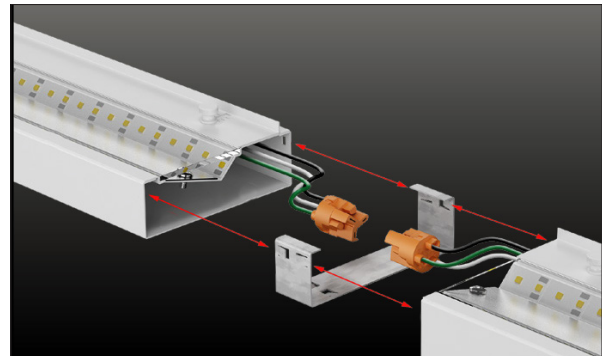

EF6-C-JN

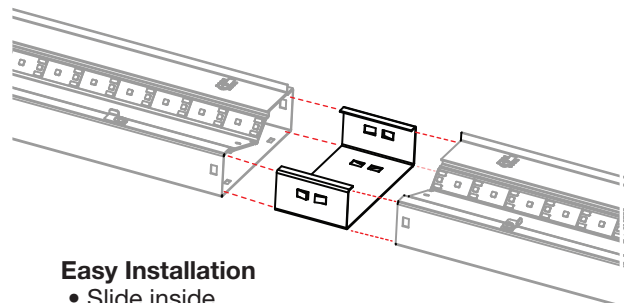

Easy Installation

- Slide inside
- Locks in place

ORDERING INFO

SERIES	FINISH
EF6-C-JN	WW White
STRAIGHT JOINER KIT White Finish	
EF6-C-JN	

Ordering Example: **EF6-C-JN-WW**