

PROJECT	TYPE	CATALOG NUMBER
---------	------	----------------

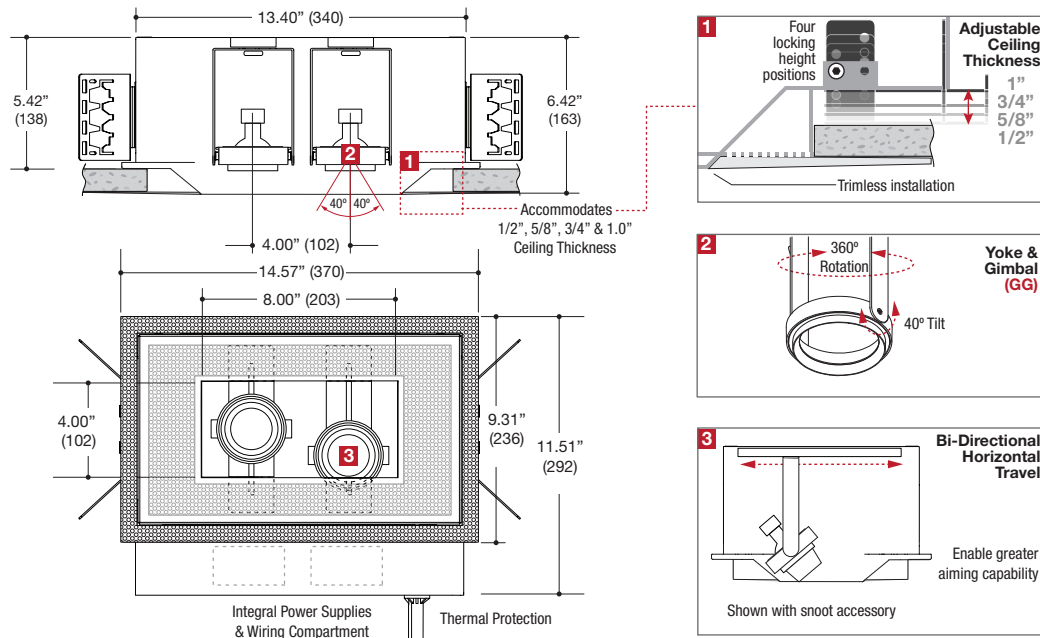

DESCRIPTION

- Two light recessed accent / downlight - small size
- All steel 18GA construction with powder coat finish
- Trimless insert with 4" x 8" open aperture
- Perforated metal mesh frame for mudding right to the aperture
- Vent holes for cooler operating temperature
- Knife-like trimless aperture edge with angle sleeve walls for clean look
- **Ceiling Cut-Out - 7.06" x 12.38"**

LAMPS (not included)

- 12V MR16 50W max - Derate Labels Available
- CMHMR16 in 20W or 39W
- LED Retrofit 15W max - Works with SORAA®
- Accepts up to 2 or more optical accessories, dependent on lamp
- Single gimbal lamp holder with up to 40° x 40° tilt aiming
- Yoke with 360°+ rotation
- Regressed adjustable yoke
- Bi-Directional Horizontal travel for extreme aiming

ELECTRICAL

- Integral electronic or toroidal transformer, metal halide ballast
- Electrical wiring compartment integrated into housing construction
- Thermal protection
- Easy maintenance access through ceiling opening
- Rated for through-branch wiring
- Dimmable (12V)

MOUNTING

- Butterfly brackets for commercial installation in drywall, and other mud in ceiling types
- Perforated plate adjusts for 1/2", 5/8", 3/4" & 1.0" ceiling thickness
- Heavy-Duty **L-Bars™** hanger bar system ordered separately

LF #LBARS4PK

LABELS

- Suitable for damp location
- Patents Pending



ORDERING INFO

SERIES	WATTAGE / LAMP	LAMP ASSEMBLY	POWER SUPPLY	VOLTAGE	FINISH	OPTIONS
MF12BN-S	020MR16X MR16 20W 035MR16X MR16 35W 050MR16X MR16 50W	GG Regressed Yoked Gimbal	ET Electronic Transformer TT Q-Tran Toroidal Transformer EB Electronic Metal Halide Ballast	1 120V 2 277V	BB Black WW White SS Silver XX Custom	CP Chicago Plenum EM Emergency Relay
MULTIFORMS MF100 Series Recessed 2-Light Knife Aperture Adjustable Accent Trimless Fixture New Construction Housing	020CM16X 20W CMHMR16 039CM16X 39W CMHMR16 015MR16X MR16 15W LED Retrofit					
MF12BN-S						

Ordering Example: **MF12BN-S-050MR16X-GG-ET-1-BB-CP**

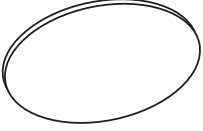
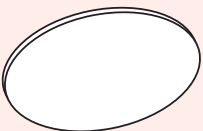
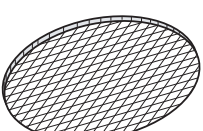
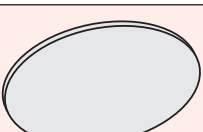
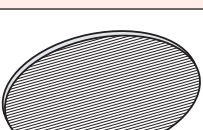
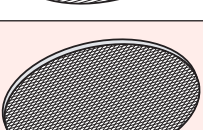
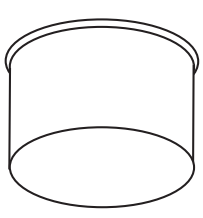
OPTICAL ACCESSORY	DESCRIPTION	LIGHT SOURCE
		SMALL
		<ul style="list-style-type: none"> • MR16 • CMHMR16 • 50mm LED
	Clear Lens	OPTB-CLR Ø2.00" (51mm) nom.
	Clear Lens - LED Film	OPTB-L-CLR Ø2.00" (51mm) nom.
	UV Lens	OPTB-UVL Ø2.00" (51mm) nom.
	Hex Cell Louver	OPTB-HXL Ø2.00" (51mm) nom.
	Diffusion Lens	OPTB-DFL Ø2.00" (51mm) nom.
	Diffusion Lens - LED Film	OPTB-L-DFL Ø2.00" (51mm) nom.
	Linear Spread Lens	OPTB-LSL Ø2.00" (51mm) nom.
	Linear Spread Lens - LED Film	OPTB-L-LSL Ø2.00" (51mm) nom.
	Prismatic Spread Lens	OPTB-PSL Ø2.00" (51mm) nom.
	Snoot - Black	OPTB-SNB Ø2.00" (51mm) nom.
	Snoot - White	OPTB-SNW Ø2.00" (51mm) nom.
	Snoot - Silver	OPTB-SNS Ø2.00" (51mm) nom.
	Snoot - White With Black Splay	OPTB-SNWB Ø2.00" (51mm) nom.
	Snoot - Silver With Black Splay	OPTB-SNSB Ø2.00" (51mm) nom.

* Other filters, colored glass, dichroics & micro-lenses available upon request