

|         |      |                |
|---------|------|----------------|
| PROJECT | TYPE | CATALOG NUMBER |
|---------|------|----------------|

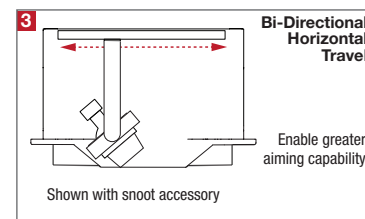
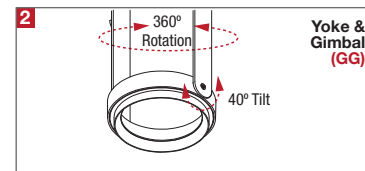
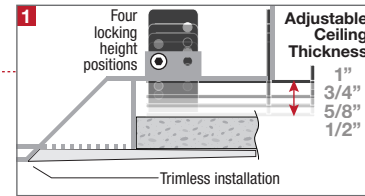
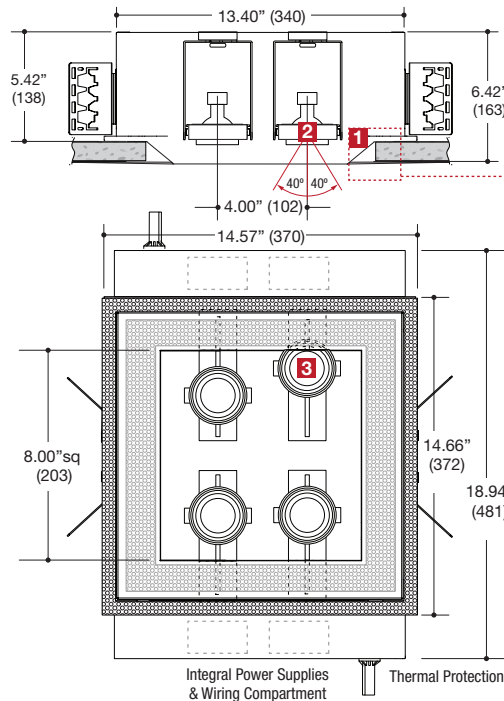

### DESCRIPTION

- Four light square recessed accent / downlight - small size
- All steel 18GA construction with powder coat finish
- Trimless insert with 8" x 8" square opening
- Perforated metal mesh frame for mudding right to the aperture
- Vent holes for cooler operating temperature
- Knife-like trimless aperture edge with angle sleeve walls for clean look
- **Ceiling Cut-Out - 12.38" x 12.38"**

### LAMPS (not included)

- 12V MR16 50W max - Derate Labels Available
- CMHMR16 in 20W or 39W
- LED Retrofit 15W max - Works with SORAA®
- Accepts up to 2 or more optical accessories, dependent on lamp
- Single gimbal lamp holder with up to 40° x 40° tilt aiming
- Yoke with 360°+ rotation
- Regressed adjustable yoke
- Bi-Directional Horizontal travel for extreme aiming

### ELECTRICAL

- Integral electronic or toroidal transformer, metal halide ballast
- Electrical wiring compartment integrated into housing construction
- Thermal protection
- Easy maintenance access through ceiling opening
- Rated for through-branch wiring
- Dimmable (12V)

### MOUNTING

- Butterfly brackets for commercial installation in drywall, and other mud in ceiling types
- Perforated plate adjusts for 1/2", 5/8", 3/4" & 1.0" ceiling thickness
- Heavy-Duty **L-Bars™** hanger bar system ordered separately  
**LF #LBARS4PK**

### LABELS

- Suitable for damp location
- Patents Pending



### ORDERING INFO

| SERIES   | WATTAGE / LAMP  | LAMP ASSEMBLY                       | POWER SUPPLY   | VOLTAGE                        | FINISH   | OPTIONS   |
|--|---|-------------------------------------|--|--------------------------------|--|---|
| <b>MF1QBN-S</b>  | <b>020MR16X</b> MR16 20W<br><b>035MR16X</b> MR16 35W<br><b>050MR16X</b> MR16 50W                        | <b>GG</b><br>Regressed Yoked Gimbal | <b>ET</b> Electronic Transformer<br><b>TT</b> Q-Tran Toroidal Transformer<br><b>EB</b> Electronic Metal Halide Ballast | <b>1</b> 120V<br><b>2</b> 277V | <b>BB</b> Black<br><b>WW</b> White<br><b>SS</b> Silver<br><b>XX</b> Custom | <b>CP</b> Chicago Plenum<br><b>EM</b> Emergency Relay |
| <b>MULTIFORMS</b><br><b>MF100 Series</b><br>Recessed 4-Light Square Knife Aperture Adjustable Accent Trimless Fixture New Construction Housing | <b>020CM16X</b> 20W CMHMR16<br><b>039CM16X</b> 39W CMHMR16<br><br><b>015MR16X</b> MR16 15W LED Retrofit |                                     |  |                                |  |   |
| <b>MF1QBN-S</b>  |   |                                     |  |                                |  |   |

Ordering Example: **MF1QBN-S-050MR16X-GG-ET-1-BB-CP**

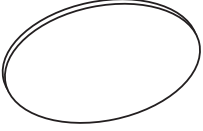
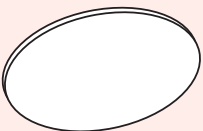
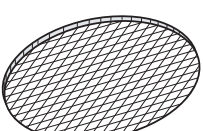
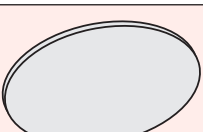
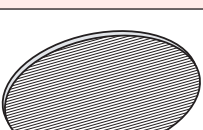
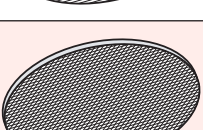
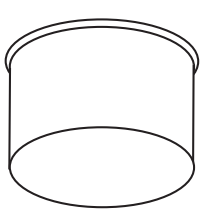
| OPTICAL ACCESSORY   | DESCRIPTION                     | LIGHT SOURCE  |
|---|---------------------------------|---|
|   |                                 | SMALL   |
|   |                                 | <ul style="list-style-type: none"> <li>• MR16</li> <li>• CMHMR16</li> <li>• 50mm LED</li> </ul> |
|    | Clear Lens                      | OPTB-CLR<br>Ø2.00" (51mm) nom.  |
|   | Clear Lens - LED Film           | OPTB-L-CLR<br>Ø2.00" (51mm) nom.  |
|    | UV Lens                         | OPTB-UVL<br>Ø2.00" (51mm) nom.  |
|   | Hex Cell Louver                 | OPTB-HXL<br>Ø2.00" (51mm) nom.  |
|  | Diffusion Lens                  | OPTB-DFL<br>Ø2.00" (51mm) nom.  |
|   | Diffusion Lens - LED Film       | OPTB-L-DFL<br>Ø2.00" (51mm) nom.  |
|  | Linear Spread Lens              | OPTB-LSL<br>Ø2.00" (51mm) nom.  |
|   | Linear Spread Lens - LED Film   | OPTB-L-LSL<br>Ø2.00" (51mm) nom.  |
|  | Prismatic Spread Lens           | OPTB-PSL<br>Ø2.00" (51mm) nom.  |
|  | Snoot - Black                   | OPTB-SNB<br>Ø2.00" (51mm) nom.  |
|   | Snoot - White                   | OPTB-SNW<br>Ø2.00" (51mm) nom.  |
|   | Snoot - Silver                  | OPTB-SNS<br>Ø2.00" (51mm) nom.  |
|   | Snoot - White With Black Splay  | OPTB-SNWB<br>Ø2.00" (51mm) nom.   |
|   | Snoot - Silver With Black Splay | OPTB-SNSB<br>Ø2.00" (51mm) nom.   |

\* Other filters, colored glass, dichroics & micro-lenses available upon request