

PROJECT	TYPE	CATALOG NUMBER
---------	------	----------------

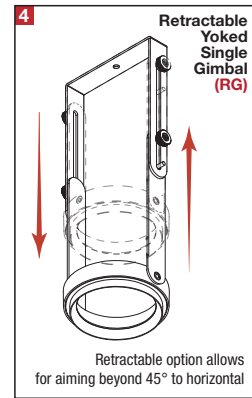
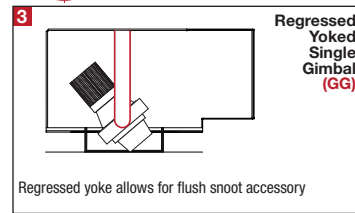
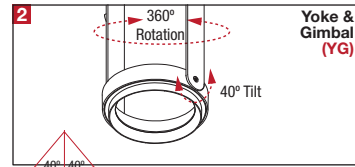
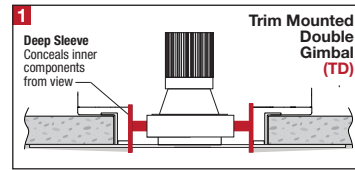
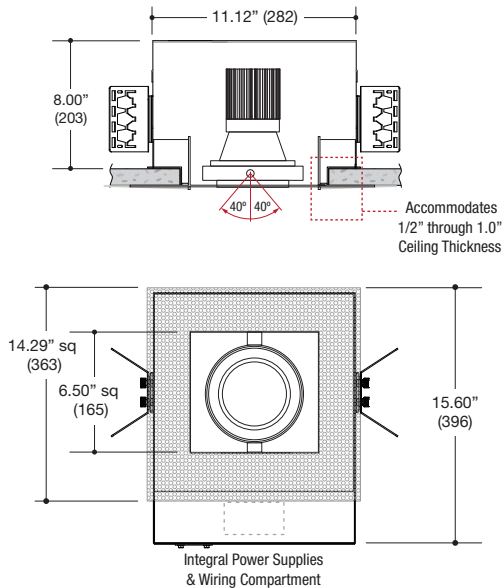

DESCRIPTION

- One light recessed accent / downlight - large size
- All steel 18GA construction with powder coat finish
- Trimless insert with 6.50" x 6.50" open aperture
- Perforated metal mesh frame for mudding right to the aperture
- Vent holes for cooler operating temperature
- Trimless insert features deep sleeve to conceal inner components
- Insert sleeve removable for maintenance
- **Ceiling Cut-Out - 7.68" x 7.68"**

LED Source

- Field-replaceable integral LED module
- Field-changeable optic
- Bridgelux or CREE - See Performance Chart
- Accepts up to 2 or more optical accessories
- Trim mounted double gimbal standard with optional single gimbal flush yoke, regressed yoke or adjusting retractable yoke

ELECTRICAL

- Integral LED driver
- Electrical wiring compartment integrated into housing construction
- Thermal protection
- Easy maintenance access through ceiling opening
- Rated for through-branch wiring
- Dimmable

MOUNTING

- Butterfly brackets for commercial installation in drywall and other mud in ceiling types
- Continuously variable plate adjusts for 1/2" through 1.0" ceilings
- Heavy -Duty **L-Bars™** hanger bar system ordered separately
LF #LBARS4PK

LABELS

- Suitable for damp location





5 YEAR WARRANTY
Limited



ORDERING INFO

SERIES	BRIDGELUX	CRI / COLOR	CREE	CRI / COLOR	BEAM	LAMP ASSEMBLY	DRIVER	VOLTAGE	FINISH	OPTIONS
MF31DN-S	22L	8027	35C	8027	N	TD	D1 Phase Dimming (120V only)	1 120V U 120-277V	BB Black WW White SS Silver XX Custom	CP Chicago Plenum EM Remotely mounted emergency LED inverter
	34L	8030 8035 8040 9027 9030 9727 9730	41C	8030 8035 8040 9527 9530 9535 9540	Narrow M Medium W Wide	TD Double Gimbal YG Yoke Gimbal Flush to Ceiling Line GG Regressed Yoked Gimbal* RG Retractable Yoked Gimbal * Required to enable flush appearance with snoot accessory.	D2 0-10V Dimming (120-277V only) D3 Lutron Hi-lume™* Forward Phase 2 wire 1% (120V only) D4 Lutron Hi-lume™* EcoSystem™ & 3 wire 1% (120-277V only) DE Lutron Hi-lume™ EcoSystem™* 1% w/Soft-On, Fade-to-Black™, 1% (120-277V only) *Consult factory for further dimming options			
REFERENCE PERFORMANCE CHART										
MF31DN-S										

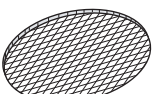
Ordering Example: **MF31DN-S-22L-8027-N-TD-D1-1-BB-CP**

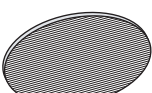
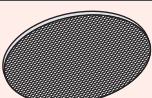
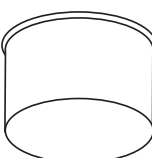
OPTICAL ACCESSORY	DESCRIPTION	LIGHT SOURCE
		LARGE
		<ul style="list-style-type: none"> • PAR30 / PAR30CMH • T4G8.5 • T6G12 • AR111 / CDMR111 • 111mm LED
	Clear Lens	OPTD-CLR
	Clear Lens - LED Film	OPTD-L-CLR
	UV Lens	OPTD-UVL
	Hex Cell Louver	OPTD-HXL
	Diffusion Lens	OPTD-DFL
	Diffusion Lens - LED Film	OPTD-L-DFL
	Linear Spread Lens	OPTBD-LSL
	Linear Spread Lens - LED Film	OPTD-L-LSL
	Prismatic Spread Lens	OPTD-PSL
	Snoot - Black	OPTD-SNB
	Snoot - White	OPTD-SNW
	Snoot - Silver	OPTD-SNS
	Snoot - White With Black Splay	OPTD-SNWB
	Snoot - Silver With Black Splay	OPTD-SNSB

* Other filters, colored glass, dichroics & micro-lenses available upon request

LED Performance Chart

BRIDGELUX

WATTAGE / LUMENS	CRI / COLOR	BEAM
22L 22W LED / 2200lm nom.	8027 80CRI / 2700K	N Narrow 17°
34L 34W LED / 2800lm nom.	8030 80CRI / 3000K	M Medium 26°
	8035 80CRI / 3500K	W Wide 52°
	8040 80CRI / 4000K	
	9027 90CRI / 2700K	
	9030 90CRI / 3000K	
	9727 97CRI / 2700K	
	9730 97CRI / 3000K	



CREE

WATTAGE / LUMENS	CRI / COLOR	BEAM
35C 35W LED / 2970lm nom.	8027 80CRI / 2700K	N Narrow 13°
41C 41W LED / 3350lm nom.	8030 80CRI / 3000K	M Medium 20°
	8035 80CRI / 3500K	W Wide 44°
	8040 80CRI / 4000K	
	9527 95CRI / 2700K	
	9530 95CRI / 3000K	
	9535 95CRI / 3500K	
	9540 95CRI / 4000K	

