

PROJECT	TYPE	CATALOG NUMBER
---------	------	----------------

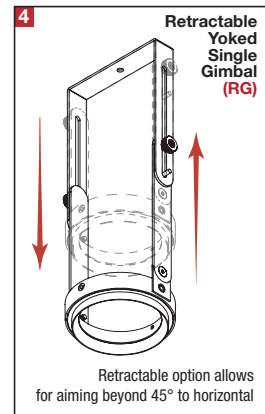
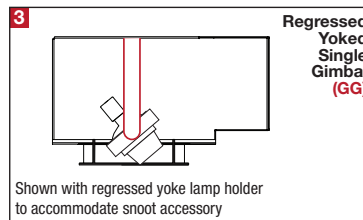
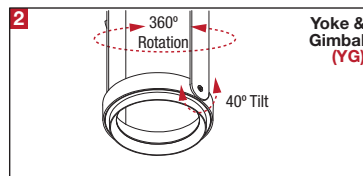
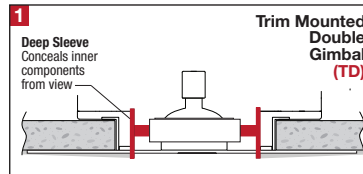
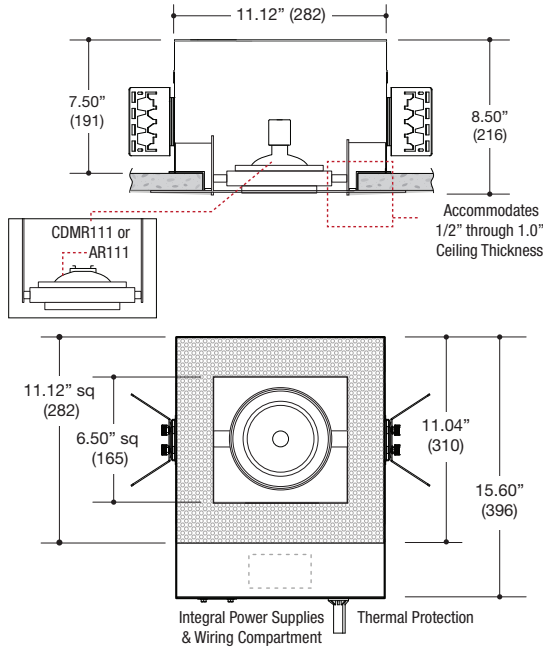

### DESCRIPTION

- One light recessed accent / downlight - large size
- All steel 18GA construction with powder coat finish
- Trimless insert with 6.50" x 6.50" open aperture
- Perforated metal mesh frame for mudding right to the aperture
- Vent holes for cooler operating temperature
- Trimless insert features deep sleeve to conceal inner components
- Insert sleeve removable for maintenance
- **Ceiling Cut-Out - 7.12" x 7.40"**

### LAMPS (not included)

- 12V AR111 Halogen 100W max - Derate Labels Available
- CDMR111 22W, 39W or 70W
- LED Retrofit 20W max - Works with SORAA®
- Double gimbal lamp holder with up to 40° x 40° tilt aiming (Actual angle dependent on source and installation condition)
- Accepts up to 2 or more optical accessories, dependent on lamp
- Trim mounted double gimbal standard with optional single gimbal flush yoke, regressed yoke or adjusting retractable yoke

### ELECTRICAL

- Integral electronic or toroidal transformer, metal halide ballast
- Electrical wiring compartment integrated into housing construction
- Thermal protection
- Easy maintenance access through ceiling opening
- Rated for through-branch wiring
- Dimmable (12V)

### MOUNTING

- Butterfly brackets for commercial installation in drywall and other mud in ceiling types
- Continuously variable plate adjusts for 1/2" through 1.0" ceilings
- Heavy -Duty **L-Bars™** hanger bar system ordered separately **LF #LBARS4PK**

### LABELS



- Suitable for damp location



### ORDERING INFO

SERIES	WATTAGE / LAMP	LAMP ASSEMBLY	POWER SUPPLY	VOLTAGE	FINISH	OPTIONS
<b>MF31DN-S</b>  MULTIFORMS MF300 Series Recessed 1-Light Straight Aperture Adjustable Accent Trimless Fixture New Construction Housing	<b>035AR11X</b> AR111 35W max	<b>TD</b> Trim Mounted Double Gimbal	<b>ET</b> Electronic Transformer <b>TT</b> Q-Tran Toroidal Transformer <b>EB</b> Electronic Metal Halide Ballast	<b>1</b> 120V <b>2</b> 277V	<b>BB</b> Black <b>WW</b> White <b>SS</b> Silver <b>XX</b> Custom	<b>CP</b> Chicago Plenum
	<b>050AR11X</b> AR111 50W max	<b>YG</b> Yoke Gimbal Flush to Ceiling Line				
	<b>100AR11X</b> AR111 100W max	<b>GG</b> Regressed Yoked Gimbal*				
	<b>022CR11X</b> CDMR111 22W <b>039CR11X</b> CDMR111 39W <b>070CR11X</b> CDMR111 70W	<b>RG</b> Retractable Yoked Gimbal				
	<b>020AR11X</b> AR111 20W LED Retrofit	* Required to enable flush appearance with snoot accessory				
<b>MF31DN-S</b>						

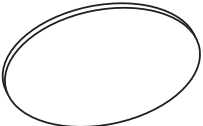
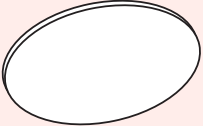
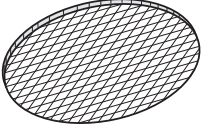
Ordering Example: **MF31DN-S-039CR11X-TD-EB-1-BB-CP**

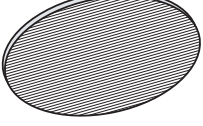
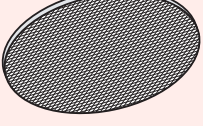
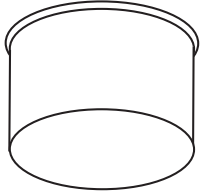
OPTICAL ACCESSORY	DESCRIPTION	LIGHT SOURCE		
		SMALL	MEDIUM	LARGE
		<ul style="list-style-type: none"> <li>• MR16</li> <li>• CMHMR16</li> <li>• 50mm LED</li> </ul>	<ul style="list-style-type: none"> <li>• PAR20</li> <li>• PAR20CMH</li> <li>• T4GU6.5</li> <li>• 70mm LED</li> </ul>	<ul style="list-style-type: none"> <li>• PAR30 / PAR30CMH</li> <li>• T4G8.5</li> <li>• T6G12</li> <li>• AR111 / CDMR111</li> <li>• 111mm LED</li> </ul>
	Clear Lens	OPTB-CLR Ø2.00" (51mm) nom.	OPTC-CLR Ø2.90" (74mm) nom.	OPTD-CLR Ø4.40" (112mm) nom.
	Clear Lens - LED Film	OPTB-L-CLR Ø2.00" (51mm) nom.	N/A	N/A
	UV Lens	OPTB-UVL Ø2.00" (51mm) nom.	OPTC-UVL Ø2.90" (74mm) nom.	OPTD-UVL Ø4.40" (112mm) nom.
	Hex Cell Louver	OPTB-HXL Ø2.00" (51mm) nom.	OPTC-HXL Ø2.90" (74mm) nom.	OPTD-HXL Ø4.40" (112mm) nom.
	Diffusion Lens	OPTB-DFL Ø2.00" (51mm) nom.	OPTC-DFL Ø2.90" (74mm) nom.	OPTD-DFL Ø4.40" (112mm) nom.
	Diffusion Lens - LED Film	OPTB-L-DFL Ø2.00" (51mm) nom.	OPTC-L-DFL Ø2.90" (74mm) nom.	OPTD-L-DFL Ø4.40" (112mm) nom.
	Linear Spread Lens	OPTB-LSL Ø2.00" (51mm) nom.	OPTC-LSL Ø2.90" (74mm) nom.	OPTD-LSL Ø4.40" (112mm) nom.
	Linear Spread Lens - LED Film	OPTB-L-LSL Ø2.00" (51mm) nom.	OPTC-L-LSL Ø2.90" (74mm) nom.	OPTD-L-LSL Ø4.40" (112mm) nom.
	Prismatic Spread Lens	OPTB-PSL Ø2.00" (51mm) nom.	OPTC-PSL Ø2.90" (74mm) nom.	OPTD-PSL Ø4.40" (112mm) nom.
	Snoot - Black	OPTB-SNB Ø2.00" (51mm) nom.	OPTC-SNB Ø2.90" (74mm) nom.	OPTD-SNB Ø4.40" (112mm) nom.
	Snoot - White	OPTB-SNW Ø2.00" (51mm) nom.	OPTC-SNW Ø2.90" (74mm) nom.	OPTD-SNW Ø4.40" (112mm) nom.
	Snoot - Silver	OPTB-SNS Ø2.00" (51mm) nom.	OPTC-SNS Ø2.90" (74mm) nom.	OPTD-SNS Ø4.40" (112mm) nom.
	Snoot - White With Black Splay	OPTB-SNWB Ø2.00" (51mm) nom.	OPTC-SNWB Ø2.90" (74mm) nom.	OPTD-SNWB Ø4.40" (112mm) nom.
	Snoot - Silver With Black Splay	OPTB-SNSB Ø2.00" (51mm) nom.	OPTC-SNSB Ø2.90" (74mm) nom.	OPTD-SNSB Ø4.40" (112mm) nom.

\* Other filters, colored glass, dichroics & micro-lenses available upon request