

PROJECT	TYPE	CATALOG NUMBER
---------	------	----------------

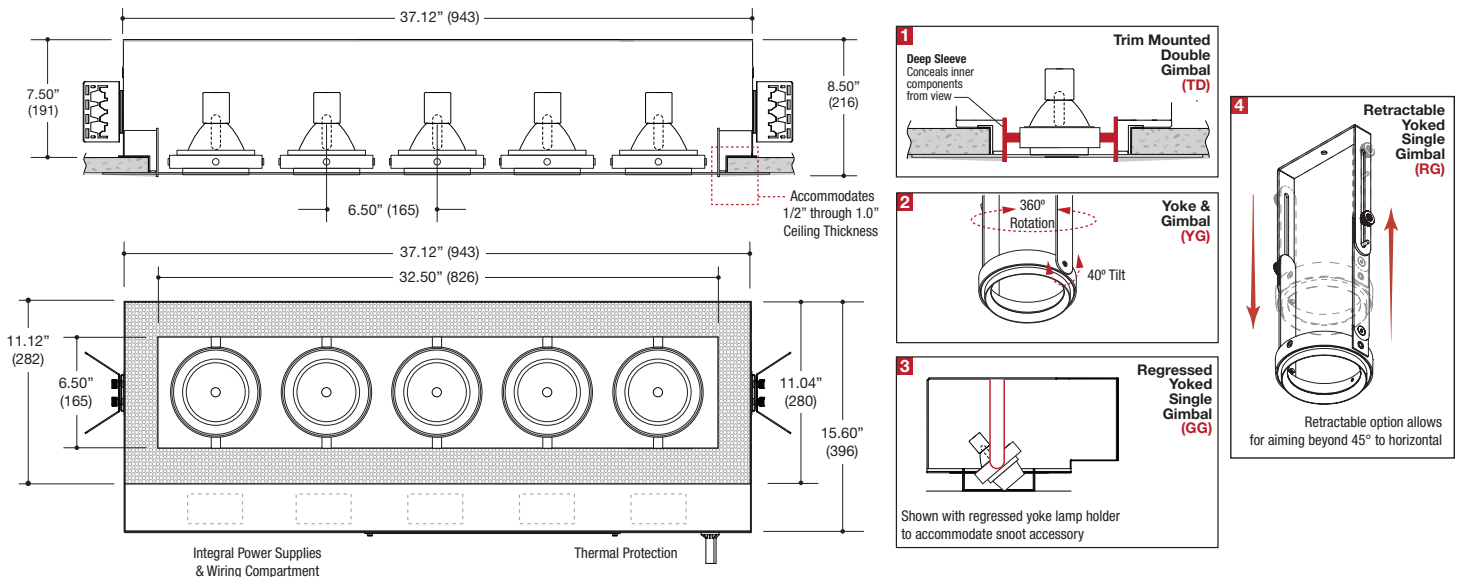

### DESCRIPTION

- Five light recessed accent / downlight - large size
- All steel 18GA construction with powder coat finish
- Trimless insert with 6.50" x 32.50" open aperture
- Perforated metal mesh frame for mudding right to the aperture
- Vent holes for cooler operating temperature
- Trimless insert features deep sleeve to conceal inner components
- Insert sleeve removable for maintenance
- **Ceiling Cut-Out - 7.12" x 33.50"**

### LAMPS (not included)

- T4 / T6 G12 20W, 39W, or 70W
- Integral aluminum reflectors in narrow, medium, and wide beams
- Accepts up to 2 or more optical accessories, dependent on lamp
- Double gimbal lamp holder with up to 40° x 40° tilt aiming
- Accepts up to 2 or more optical accessories, dependent on lamp
- Trim mounted double gimbal standard with optional single gimbal flush yoke, regressed yoke or adjusting retractable yoke

### ELECTRICAL

- Integral metal halide ballast
- Electrical wiring compartment integrated into housing construction
- Thermal protection
- Easy maintenance access through ceiling opening
- Rated for through-branch wiring

### MOUNTING

- Butterfly brackets for commercial installation in drywall and other mud in ceiling types
- Continuously variable plate adjusts for 1/2" through 1.0" ceilings
- Heavy -Duty **L-Bars™** hanger bar system ordered separately  
**LF #LBARS4PK**

### LABELS





- Suitable for damp location



### ORDERING INFO

SERIES	WATTAGE / LAMP	BEAM	LAMP ASSEMBLY	POWER SUPPLY	VOLTAGE	FINISH	OPTIONS
<b>MF35DN-S</b>	<b>020T6G1</b> T4/T6 G12 20W <b>039T6G1</b> T4/T6 G12 39W <b>070T6G1</b> T4/T6 G12 70W	<b>N</b> Narrow <b>M</b> Medium <b>W</b> Wide	<b>TD</b> Trim Mounted Double Gimbal <b>YG</b> Yoke Gimbal Flush to Ceiling Line <b>GG</b> Regressed Yoked Gimbal* <b>RG</b> Retractable Yoked Gimbal  * Required to enable flush appearance with snoot accessory	<b>EB</b> Electronic Metal Halide Ballast	<b>1</b> 120V <b>2</b> 277V	<b>BB</b> Black <b>WW</b> White <b>SS</b> Silver <b>XX</b> Custom	<b>CP</b> Chicago Plenum
<b>MULTIFORMS MF300 Series</b> Recessed 5-Light Straight Aperture Adjustable Accent Trimless Fixture New Construction Housing							
<b>MF35DN-S</b>							

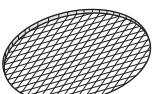
Ordering Example: **MF35DN-S-039T6G1-N-TD-EB-1-BB-CP**

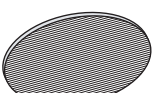
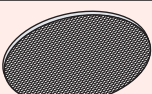
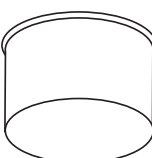
OPTICAL ACCESSORY	DESCRIPTION	LIGHT SOURCE
		LARGE
		<ul style="list-style-type: none"> <li>• PAR30 / PAR30CMH</li> <li>• T4G8.5</li> <li>• T6G12</li> <li>• AR111 / CDMR111</li> <li>• 111mm LED</li> </ul>
	Clear Lens	OPTD-CLR
	Clear Lens - LED Film	OPTD-L-CLR
	UV Lens	OPTD-UVL
	Hex Cell Louver	OPTD-HXL
	Diffusion Lens	OPTD-DFL
	Diffusion Lens - LED Film	OPTD-L-DFL
	Linear Spread Lens	OPTBD-LSL
	Linear Spread Lens - LED Film	OPTD-L-LSL
	Prismatic Spread Lens	OPTD-PSL
	Snoot - Black	OPTD-SNB
	Snoot - White	OPTD-SNW
	Snoot - Silver	OPTD-SNS
	Snoot - White With Black Splay	OPTD-SNWB
	Snoot - Silver With Black Splay	OPTD-SNSB

\* Other filters, colored glass, dichroics & micro-lenses available upon request

## LED Performance Chart

### BRIDGELUX

WATTAGE / LUMENS	CRI / COLOR	BEAM
<b>22L</b> 22W LED / 2200lm nom.	<b>8027</b> 80CRI / 2700K	<b>N</b> Narrow 17°
<b>34L</b> 34W LED / 2800lm nom.	<b>8030</b> 80CRI / 3000K	<b>M</b> Medium 26°
	<b>8035</b> 80CRI / 3500K	<b>W</b> Wide 52°
	<b>8040</b> 80CRI / 4000K	
	<b>9027</b> 90CRI / 2700K	
	<b>9030</b> 90CRI / 3000K	
	<b>9727</b> 97CRI / 2700K	
	<b>9730</b> 97CRI / 3000K	



### CREE

WATTAGE / LUMENS	CRI / COLOR	BEAM
<b>35C</b> 35W LED / 2970lm nom.	<b>8027</b> 80CRI / 2700K	<b>N</b> Narrow 13°
<b>41C</b> 41W LED / 3350lm nom.	<b>8030</b> 80CRI / 3000K	<b>M</b> Medium 20°
	<b>8035</b> 80CRI / 3500K	<b>W</b> Wide 44°
	<b>8040</b> 80CRI / 4000K	
	<b>9527</b> 95CRI / 2700K	
	<b>9530</b> 95CRI / 3000K	
	<b>9535</b> 95CRI / 3500K	
	<b>9540</b> 95CRI / 4000K	

