

PROJECT	TYPE	CATALOG NUMBER
---------	------	----------------

Measurements in () are metric equivalents.

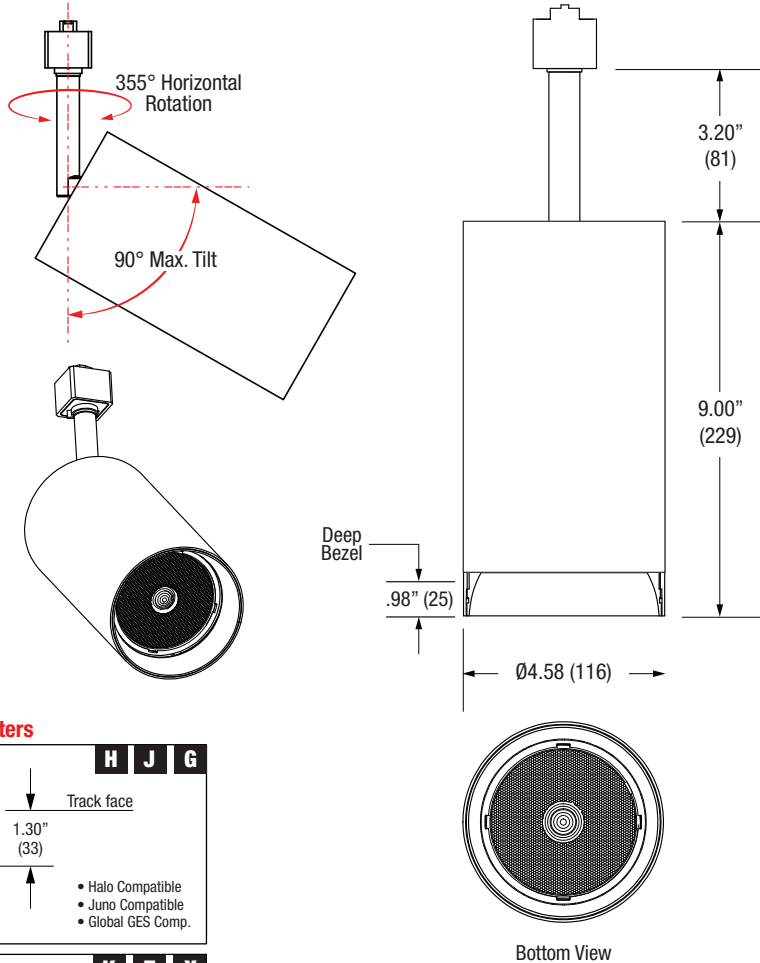

Specifications

MONOPOINT

- 4.58" diameter cylinder shaped trackhead
- 0.98" deep bezel
- 0°-90° vertical tilt
- 355° horizontal rotation
- Constant friction
- Die cast aluminum housing
- Powder coat finish

LED SOURCE

CREE

- 26W / 2478lm del. @ 80CRI min / 3000K Narrow Beam
- Accepts up to 2 optical accessories
- 34W / 3057lm del. @ 80CRI min / 3000K Narrow Beam

ELECTRICAL

- Integral LED driver
- Phase Dimmable

MOUNTING

- Compatible with Halo®, Juno®, Global® GES track, Global® XTS track, Global® TEK track

LABELS

- Suitable for dry location

Track Adapters

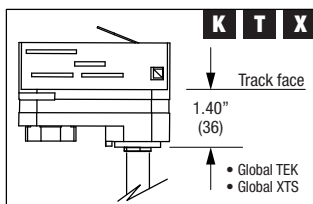
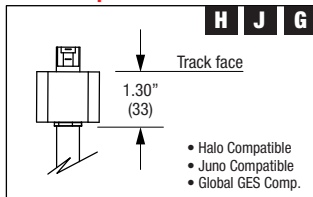



Halo® is a registered trademark of Cooper Industries,
Juno® is a registered trademark of Juno Lighting,
Global® is a registered trademark of Nordic Aluminium.







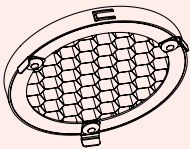
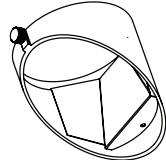
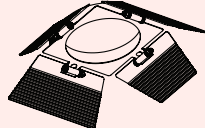

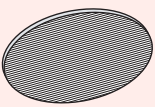

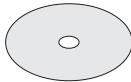
ORDERING INFO

SERIES	ADAPTOR	LED MODULE	CRI / COLOR	BEAM	DRIVER / VOLTAGE	HSG FINISH	BEZEL FINISH
TRA22D EMMA Series Cylinder Trackhead Die Cast Aluminum Adjustable Aim	H Halo® compatible*	26C 26W LED 2478lm	8027 80CRI / 2700K	N Narrow 14°	D11 Phase Dimmable @ 120V	W White	W White
	J Juno® compatible*						
	G Global® GES compatible*	34C 34W LED 3057lm	8035 80CRI / 3500K	W Wide 42°	S Silver	S Silver	
	T Global® TEK compatible						Delivered Lumens
	K Global® HTEK compatible		8050 80CRI / 5000K				
	X Global® XTS compatible		9227 92CRI / 2700K				
			9230 92CRI / 3000K				
			9235 92CRI / 3500K				
			9240 92CRI / 4000K				
			9250 92CRI / 5000K				
TRA22D							

Ordering Example: **TRA22-D-J-26C-8030-M-D11-W-B**

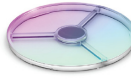
OPTICAL ACCESSORY	DESCRIPTION	EF208D / EF408D
		LED
	Hex Cell Louver - Black	OPT-EF208D-HXL
	Wallwash - White	OPT-EF208D-WWWW
	Wallwash - Black	OPT-EF208D-WWBB
	Barn Doors - White	OPT-EF208D-BDWW
	Barn Doors - Black	OPT-EF208D-BDBB
	Diffused Lens	OPT-EF208D-P-DFL
	Linear Spread Lens	OPT-EF208D-P-LSL

OPTICAL ACCESSORY	DESCRIPTION	<ul style="list-style-type: none"> • PAR30 • SNAP SYSTEM • SORAA® LED
	Hex Cell Louver Louver Snap 40° Cutoff	OPTD-SLX30-HXL Ø4.00" (102mm) nom.
	Diffusion Lens LED Film	OPTD-SLX30-L-DFL Ø4.00" (102mm) nom.
	Linear Snap 10° x 36°	OPTD-SLX30-LSL Ø4.00" (102mm) nom.
	Linear Snap 10° x 60°	OPTD-SLX30-LSW Ø4.00" (102mm) nom.
	17° Beam Spreader Snap	OPTD-SLX30-NAR17 Ø4.00" (102mm) nom.
	25° Beam Spreader Snap	OPTD-SLX30-MED25 Ø4.00" (102mm) nom.
	36° Beam Spreader Snap	OPTD-SLX30-WID36 Ø4.00" (102mm) nom.
	60° Beam Spreader Snap	OPTD-SLX30-VWD60 Ø4.00" (102mm) nom.
	1/4 CTO CCT Shifter Snap	OPTD-SLX30-14CTO Ø4.00" (102mm) nom.
	1/2 CTO CCT Shifter Snap	OPTD-SLX30-12CTO Ø4.00" (102mm) nom.
	3/4 CTO CCT Shifter Snap	OPTD-SLX30-34CTO Ø4.00" (102mm) nom.
	Flat Top 36° x 36°	OPTD-SLX30-FT3 Ø4.00" (102mm) nom.
	Clear Lens	OPTD-SLX30-CLR Ø4.00" (102mm) nom.
	Enhance Lens	OPTD-SLX30-ENH Ø4.00" (102mm) nom.
	Aimable Lens	OPTD-SLX30-AIM Ø4.00" (102mm) nom.