

LED

INTEGRAL DRIVER

SMALL

PROJECT	TYPE	CATALOG NUMBER
---------	------	----------------

Measurements in ( ) are metric equivalents.

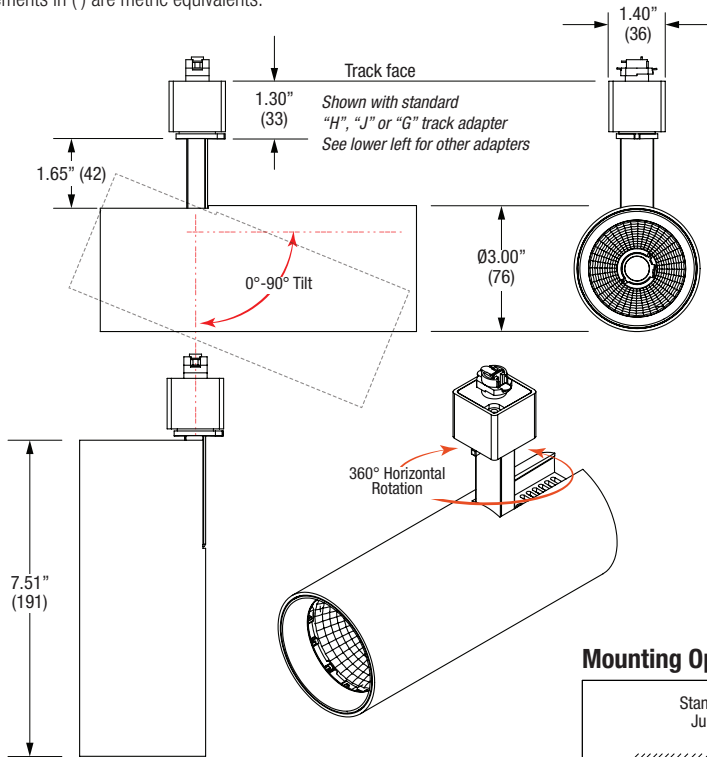

## Specifications

### TRACKHEAD

- 3.00" diameter cylinder shaped trackhead
- 0° - 90° vertical tilting / 360° horizontal rotation
- Constant friction
- Die cast aluminum housing
- LED optical grade reflector
- Powder coat finish

### LED SOURCE

#### CREE

- ValuDIM™ Warm dimming
- Field replaceable optics available
- Will accept 1 lens and 1 louver
- Thru ventilation passively cooled thermal management

### ELECTRICAL

- Fully integral LED driver
- Phase dimmable power supply

### MOUNTING

- Compatible with Halo®, Juno®, Global® GES track, Global® XTS track, Global® TEK track, or Global® HTEK track
- Monopoint to J-box

### LABELS

- Suitable for dry location

### Mounting Option

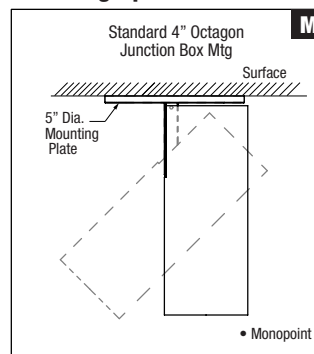

### Track Adapters

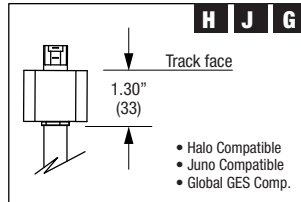
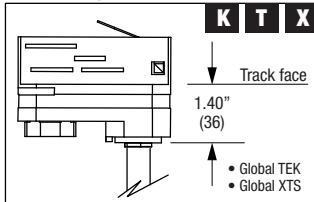

Halo® is a registered trademark of Cooper Industries,  
Juno® is a registered trademark of Juno Lighting,  
Global® is a registered trademark of Nordic Aluminium.

**5 YEAR WARRANTY**  
Limited

## ORDERING INFO QuikShip In RED - 10 pc Minimum - Consult factory for quantities of 100 or more

SERIES	ADAPTER	WATTAGE	CRI / COLOR	BEAM	POWER SUPPLY / VOLTAGE	FINISH
<b>TRA20B</b> LANIE Trackhead Die-Cast Aluminum Adjustable Aim	<b>H</b> Halo® compatible*	<b>08C</b> 08W LED 914 lm del.	<b>8027</b> 80CRI / 2700K	<b>N</b> Narrow 13°	<b>D11</b> Phase Dimming 120V	<b>BB</b> Matte Black
	<b>J</b> Juno® compatible*					
	<b>G</b> Global® GES compatible*	<b>13C</b> 13W LED 1230 lm del.	<b>8030</b> 80CRI / 3000K	<b>M</b> Medium 25°	<b>LD2</b> Non Dimming 277V (K adaptor only)	<b>WW</b> White
	<b>T</b> Global® TEK compatible*					
<b>K</b> Global® HTEK compatible**	<b>19C</b> 19W LED 1768 lm del.	<b>8035</b> 80CRI / 3500K	<b>W</b> Wide 36°	<b>DMU</b> Dimming Multiple Forward/Reverse Phase (@ 120V only)	Consult factory for custom colors.	
<b>X</b> Global® XTS compatible*						
<b>M</b> Monopoint***	<b>26C</b> 26W LED 2377 lm del. Delivered @ 80CRI / 3000K Narrow Beam	<b>8040</b> 80CRI / 4000K	<b>V</b> Very Wide 51°	<b>Adapters:</b> * D11 H/J/G/T/X/M Only ** LD2 K Only *** DMU M Only		
	<b>ValuDIM™</b> <b>15V</b> 15W LED / 813 lm del. / 3000-1800K Warm Dimming Delivered @ 92CRI / 3000K Narrow Beam	<b>9220</b> 92CRI / 3000-1800K Warm Dimming (ValuDIM Only)			<b>ValuDIM™</b> <b>N</b> Narrow 17° <b>M</b> Medium 25° <b>W</b> Wide 38°	

Ordering Example: **TRA20B-T-26C-8030-N-D11-WW**

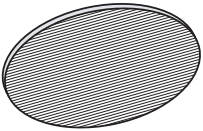
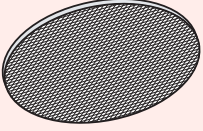
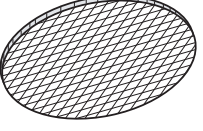
OPTICAL ACCESSORY	DESCRIPTION	LIGHT SOURCE
		SMALL
		• 65mm LED
	Diffusion Lens	OPT-TRA20B-P-DFL Ø2.60" (65mm) nom.
	Linear Spread Lens	OPT-TRA20B-P-LSL Ø2.60" (65mm) nom.
	Prismatic Spread Lens	OPT-TRA20B-P-PSL Ø2.60" (65mm) nom.
	Hex Cell Louver	OPT-TRA20B-HXL Ø2.60" (65mm) nom.

\* Other filters, colored glass, dichroics & micro-lenses available upon request